

# Láminas (5 años)



[www.educacionvial.dgt.es](http://www.educacionvial.dgt.es)



¡Hola! Me llamo  
Mara y soy un peatón.

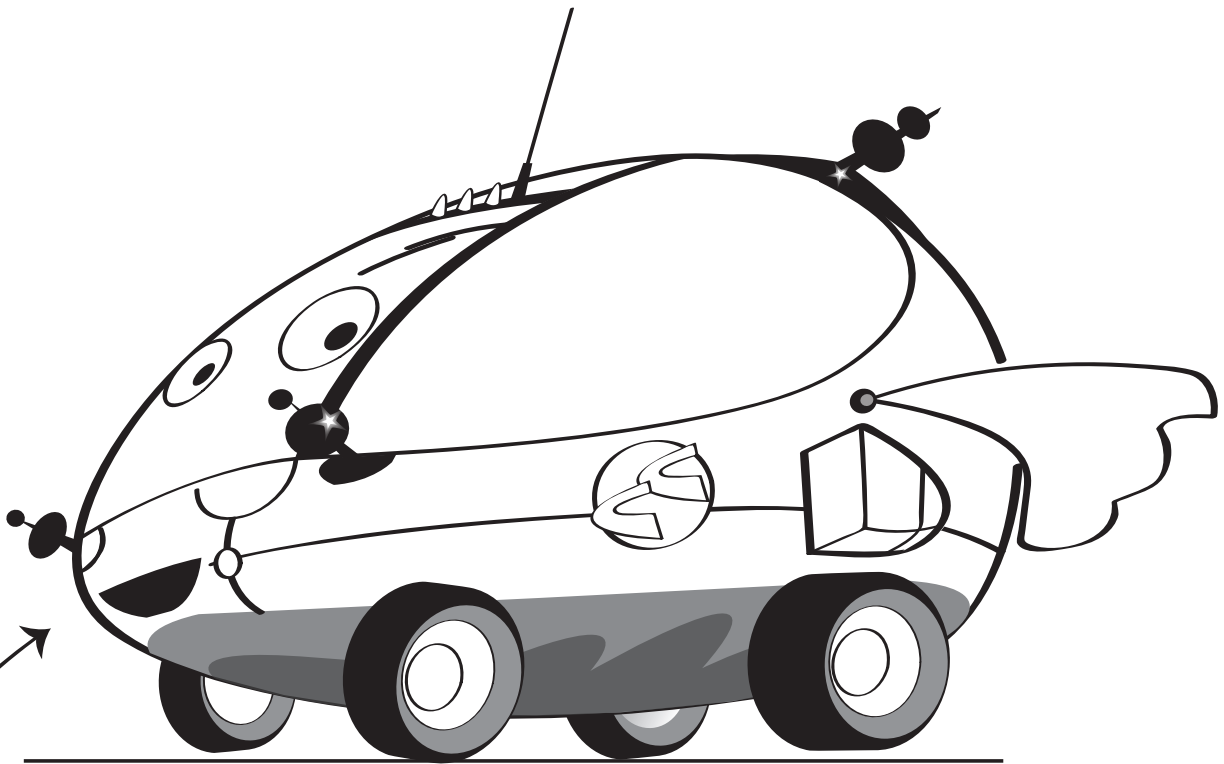

¡Y yo "Cosmocar"! Soy un coche sideral.

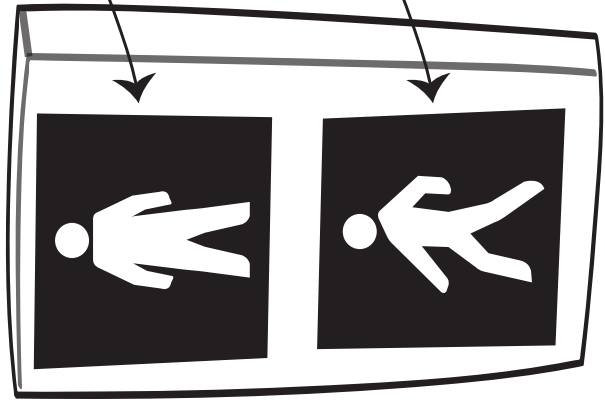

El muñeco rojo.

El muñeco verde

El semáforo.

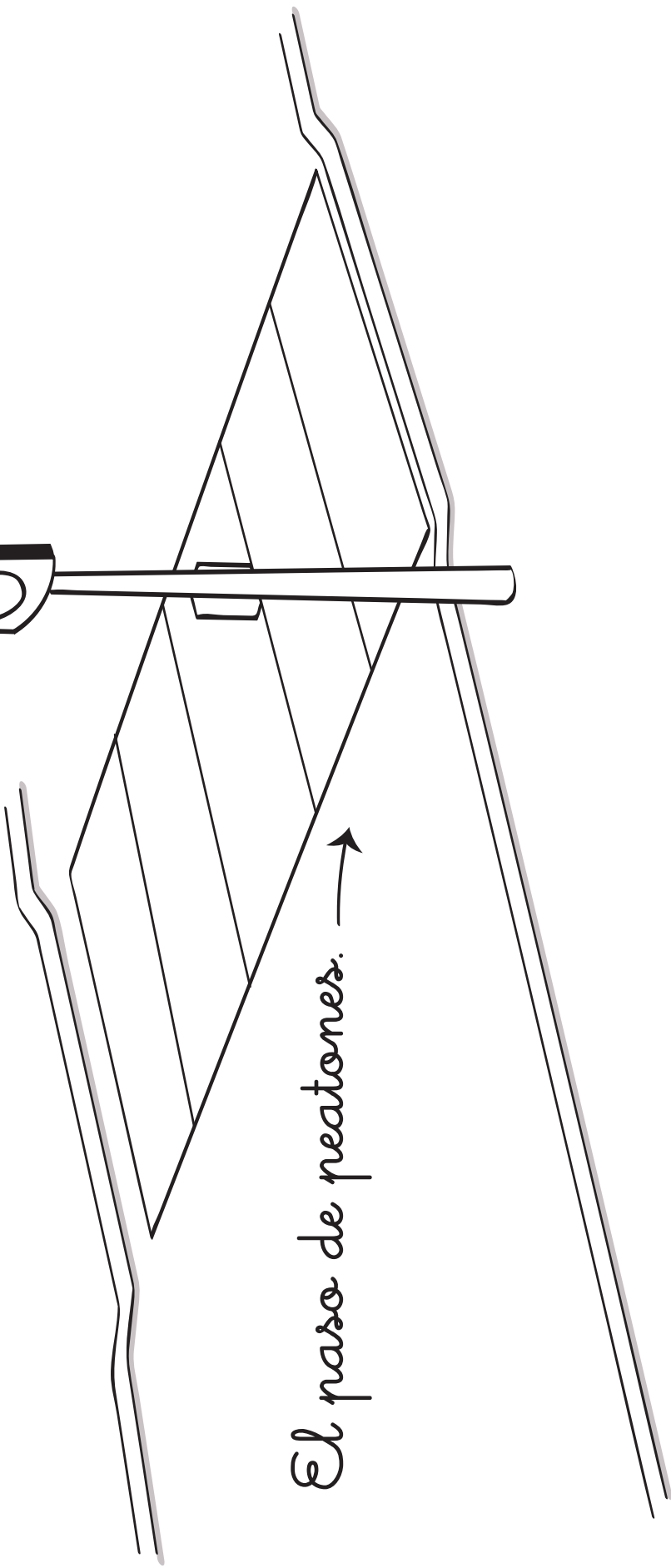
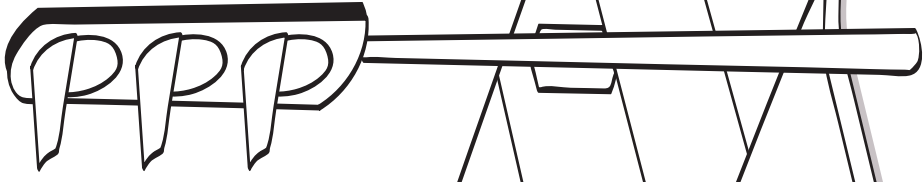

El paso de peatones.



El cinturón de seguridad

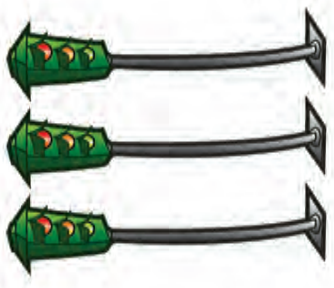

1 2 3 4 5

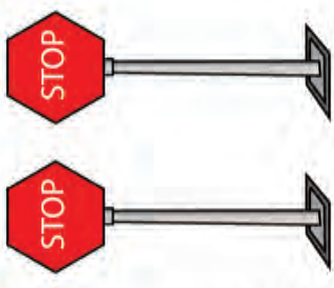

1 2 3 4 5

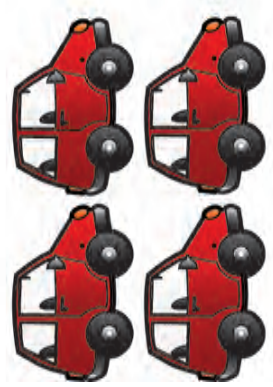

1 2 3 4 5



1 2 3 4 5



1 2 3 4 5

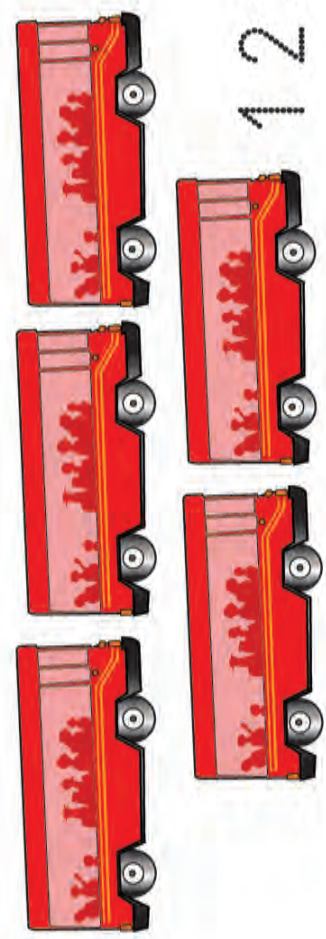

1 2 3 4 5

Rodea con un círculo el número de elementos.





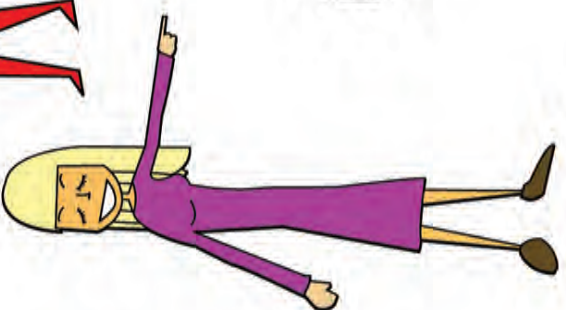
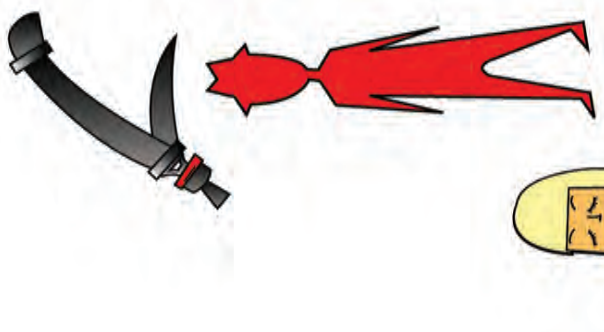

Une con una línea lo que  
le falta a cada dibujo.

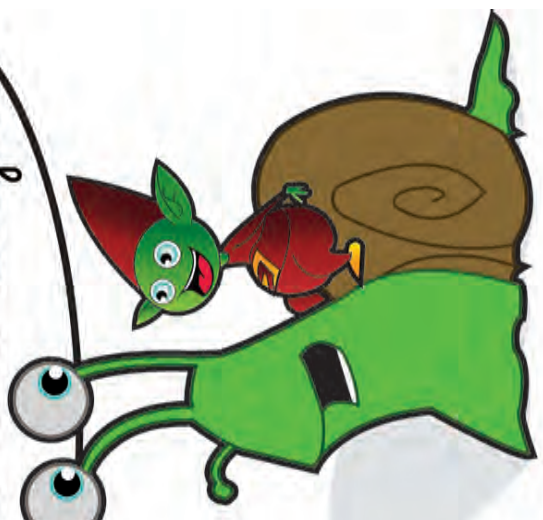



S \_ m \_ f \_ r \_

P \_ l \_ c \_

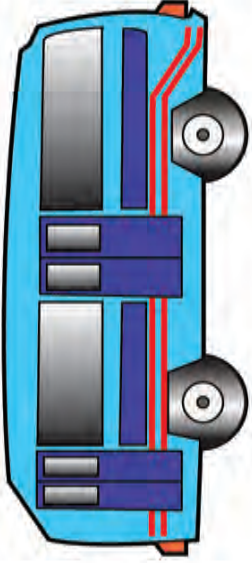

A \_ t \_ b \_ s



P \_ s \_ d \_ r \_ t \_ n \_ s

C \_ ch \_

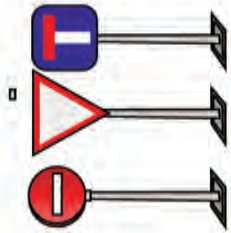

S \_ ñ \_ l \_ s

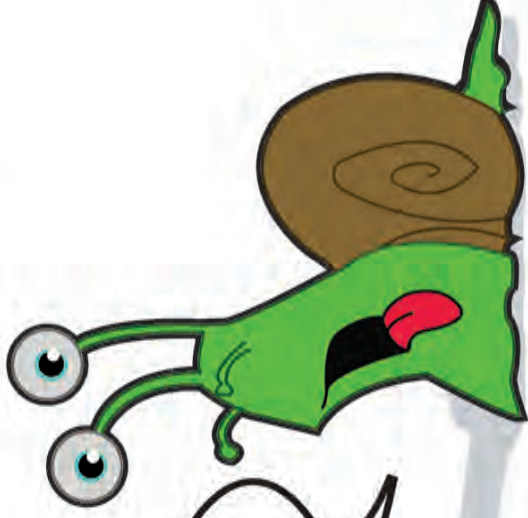

Completa la palabra con las letras que faltan.

Éste es el muñeco :

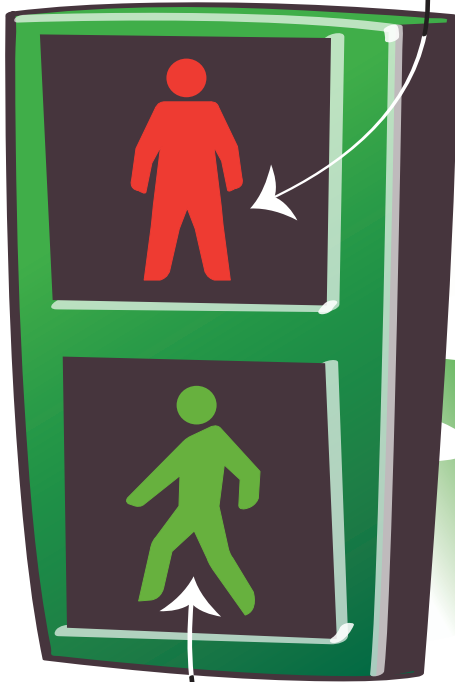

Éste es el muñeco :

¡ Ese soy yo !  
Y digo :



¡ Hola !  
Yo digo :

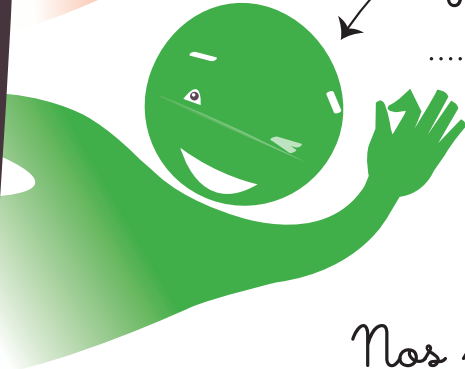

Nos puedes  
colorear

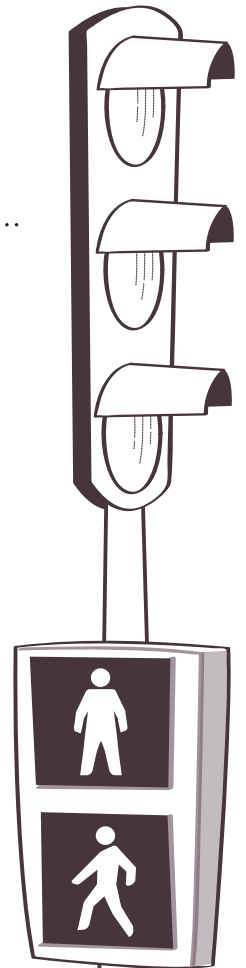
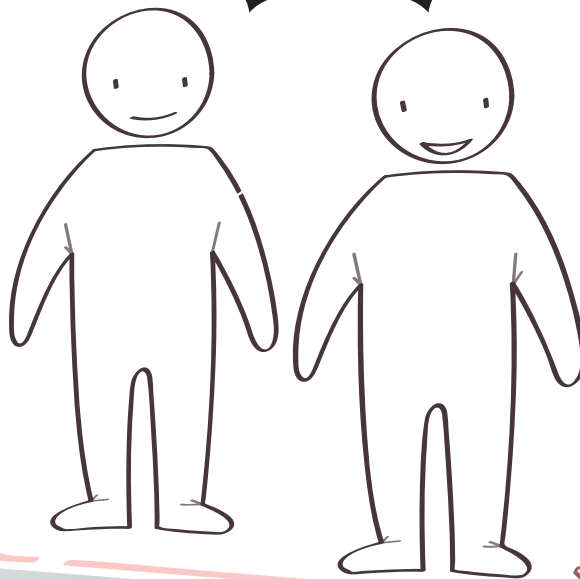

El muñeco que está quieto es el : .....

El muñeco que anda es el : .....